

Top View

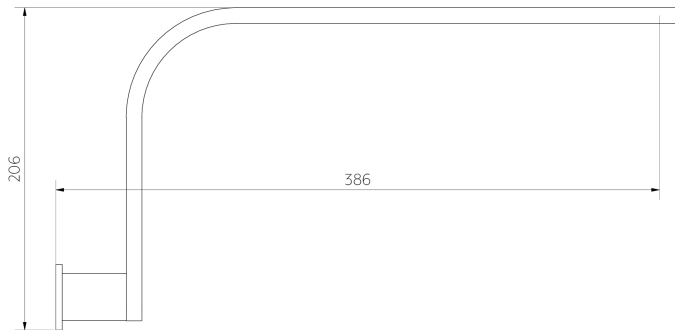

Side View



Front View

Note: Dimensions are nominal measurements only

SPECIFICATIONS

RECOMMENDED USE

Domestic / Commercial

MATERIAL

Stainless Steel 304

TEMPERATURE RATING

Maximum continuous working temperature 75°C
If the water temperature exceeds 75°C, an approved tempering valve must be fitted

PRESSURE RATING

Recommended minimum working pressure 0.2 Bar
Recommended maximum working pressure 5 Bar
Hot and cold water inlet pressure should be equal

SUITABLE HOT WATER UNITS

Storage tank: Yes
Continuous Flow: Yes
Gravity Feed: Suitable

INSTALLATION GUIDE

Note: This product must be installed by a licensed plumber. This is a general installation guide - there are many factors involved that can alter the installation method. **AU/NZ:** For installations within Australia and New Zealand, this product must be installed in compliance with AS/NZS 3500. **UK:** For installations in the United Kingdom this product must be installed in compliance with the Water Supply (Water Fittings) Regulations and Water Supply (Water Fittings) (Scotland) Byelaws. **Other:** For installations outside these countries, this product must be installed in compliance with the standards in your respective country.



* Please note this shower arm is designed to be used in conjunction with Nesso Shower Head 250mm.

- ① Use a hack saw and trim wall outlet so that a maximum of 15mm protrudes from wall finish.

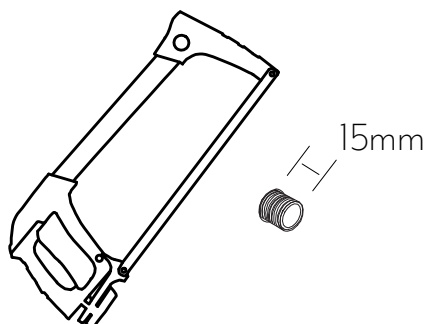

- ② Undo grub screws and remove BP connection from shower rail

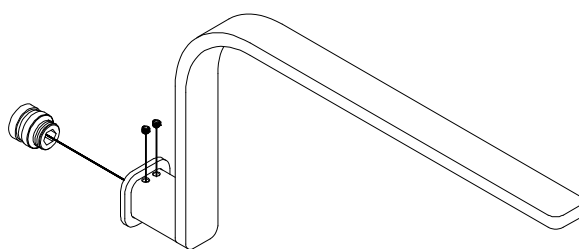

- ③ Apply thread tape to water water outlet. Screw on BP connection using a 10mm Allen Key to tighten.

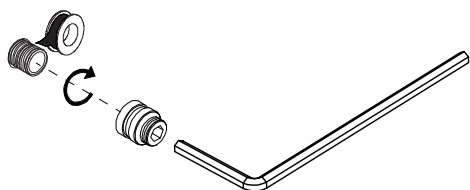

- ④ Tighten grub screws with provided Allen Key, ensuring shower arm is tight and level.

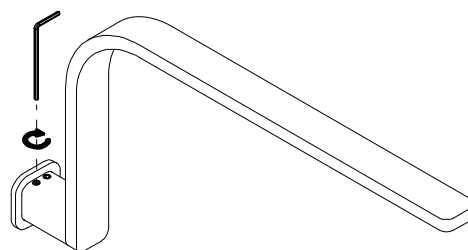

IN THE BOX

1 x Shower arm

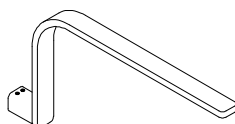

1 x Back plate



Regularly clean with mild liquid detergent or soap and water



DO NOT use cream cleaners or bleach. These substances are abrasive

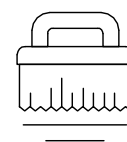

DO NOT use cleaning pads with abrasive surfaces as this may scratch the material