

Front View

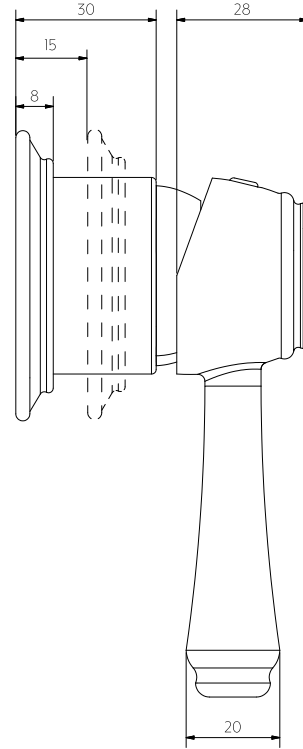

Side View

Note: Dimensions are nominal measurements only

SPECIFICATIONS

RECOMMENDED USE

Domestic

MATERIAL

Solid Brass

INSTALLATION GUIDE

This product must be installed by a licensed plumber. This is a general installation guide - there are many factors that are involved that can alter the installation method. This product install must comply with AS/NZS 3500.



NOTE: See Minimal Mixer Body installation guide for In-Wall set out.

- ① Choose sleeve based on how far your In-wall protrudes from finish wall and slide on.

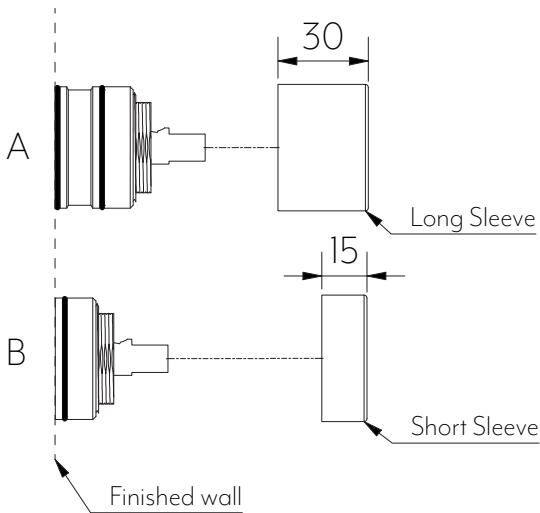

- ② Slide back plate on. Screw dome on.

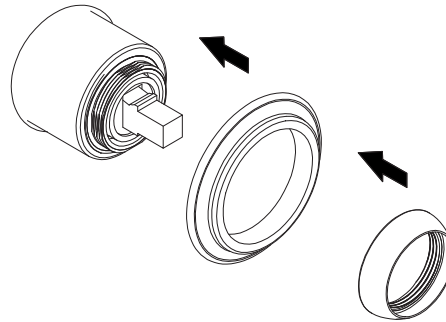

- ③ Tighten grub screw with allen key. Replace grub screw cap.

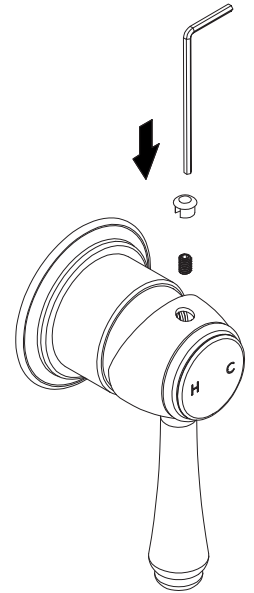

MIXER OPERATION

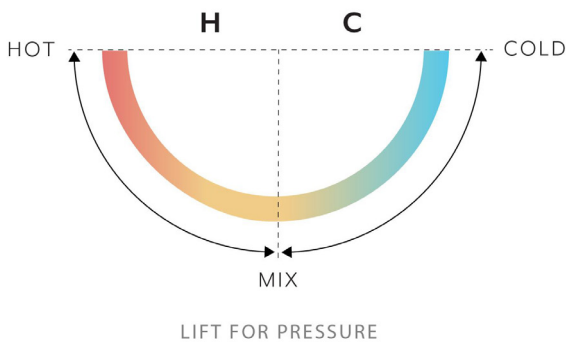

WHAT'S IN THE BOX

1. Back plate
2. Long sleeve
3. Dome
4. Grubs screw cap
5. Grub screw
6. Handle
7. Short sleeve
8. Allen key

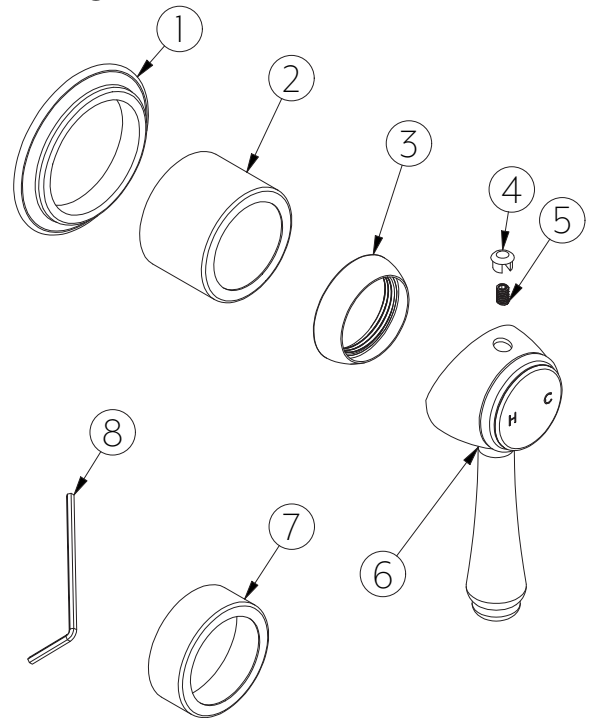

Regularly clean with mild liquid detergent or soap and water



DO NOT use cream cleaners or bleach. These substances are abrasive

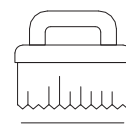

DO NOT use cleaning pads with abrasive surfaces as this may scratch the material